

Estimation of the Insulation Deterioration of Metallurgical Ladle by Use of RBFNN Models

Nikolinka Christova

Department of Automation of Industry
University of Chemical Technology and Metallurgy
Sofia, Bulgaria
e-mail: nchrist@uctm.edu

Gancho Vachkov

School of Engineering and Physics
The University of the South Pacific (USP)
Suva, Fiji
e-mail: gancho.vachkov@gmail.com

Abstract—A model-based approach for estimation and diagnosis of the deterioration in the metallurgical ladle insulation is proposed in this paper. It is based on using the diverse information that comes from the so called thermovision analysis (thermographic images), which show the temperature profile on the surface of the ladle.

A group of Radial Basis Function Neural Network (RBFNN) models with different structures is developed and used for such estimation. Each model has different number of input parameters and a different output, in order to estimate the respective parameters of the insulation deterioration (the defect), such as its depth, width and shape.

The created RBFNN models are a kind of *diagnostic models* because they solve the *inverse problem*, namely: finding the parameters of the defect, taking into account the available measured *symptoms* (the selected parameters from the thermographic images).

The estimation results from all proposed diagnostic models are shown and discussed in the paper, by using simulated input-output data sets. Respective suggestions and procedure for selection of the best diagnostic model are also given in the paper.

Keywords - Deterioration, Diagnosis, Inverse Problem, Metallurgical Ladle, RBFNN models, Infrared Thermography

I. INTRODUCTION

Nondestructive monitoring and estimation of different kinds of deterioration in the metallurgical equipment is very import for achieving smooth and faultless operation of the metallurgical processes [2, 5, 6].

Metallurgical units, such as converters, industrial furnaces and ladles work continuously with extremely high temperatures that are needed for the metal processing. As a result the refractory linings (insulations) in these units undergo gradual deterioration and wearing with time that is caused mainly by thermal stress and chemical attack that result in loss of heat transfer capability [5, 6].

A model-based approach [1, 3, 4] for estimation and diagnosis of the ladle lining damages is proposed in this paper. It is based on using the diverse information that comes from the so called thermovision analysis (thermographic images), which show the temperature profile on the surface of the ladle [5, 6].

A group of Radial Basis Function Neural Network (RBFNN) models [8] have been proposed and developed in this paper, in order to estimate the size, as well as other parameters of the insulation deterioration (the defect). These

models differ by the selected number and the list of the input parameters, and also by the structure of the RBFNN model, namely the number of the assumed RBFs. The created RBFNN models are considered as a kind of *diagnostic models* because they solve the *inverse problem*, namely: finding the parameters of the deterioration (the depth, width, shape etc.) based on the available *symptoms* (the selected parameters from the thermographic images).

II. STATEMENT OF THE PROBLEM

The high temperature molten steel, which is produced in a converter or electric furnace, is tapped into a metallurgical ladle through the furnace gate.

The ladle is a huge container used in steelworks as a device to transport the molten steel to other production stages. The ladle walls are insulated by refractory materials that need to withstand the high temperatures of the molten metal during the casting process. These materials used for insulation are heat proof, but also they are thermal shock-sensitive. Therefore the good quality and good condition of the ladle's insulation at any time of the operation process are of utmost importance for the faultless and save operation of the whole metallurgical equipment [2, 5, 6].

If the insulation deteriorates gradually and goes beyond a certain limit, without being changed (repaired) at the right time, the ladle will burst and the molten metal will gush out in the foundry. This is a serious failure that needs emergency stop of the whole metallurgical process with all the subsequent losses.

A typical failure (called also defect) that can occur in the lining of the metallurgical ladle is a kind of a small hole with cylindrical, ellipsoidal or other arbitrary shape within the insulation. It is still invisible from the outer surface of the ladle, but is dangerous, because it affects the structural integrity of the whole equipment. Therefore getting a proper and timely knowledge about the current refractory thickness and lining condition of the unit is crucial for taking the *proper decision*: it is *save to continue* with the operation of this unit or the operation should be *suspended* for change (repair) of the insulation of the metallurgical unit [2, 3, 5].

The temperature profile at different depths of the ladle's defects, including the ladle's surface can be obtained as a result of the infrared thermovision analysis, in the form of thermographic images, is shown in Fig. 1, Fig. 2 and Fig. 3. As seen, such temperature profile is rich with information

and selected portions of it could be used as reliable symptoms in the general diagnostic problem to properly estimate the refractory's condition [2, 5, 6, 7].

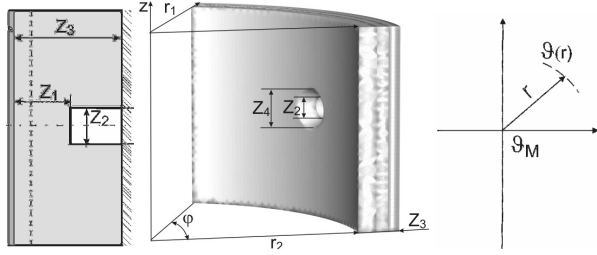

Figure 1. 2D and 3D images of typical ladle lining wears.

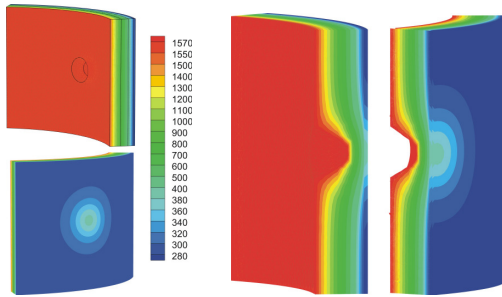

Figure 2. Images with the temperature profile of the defect.

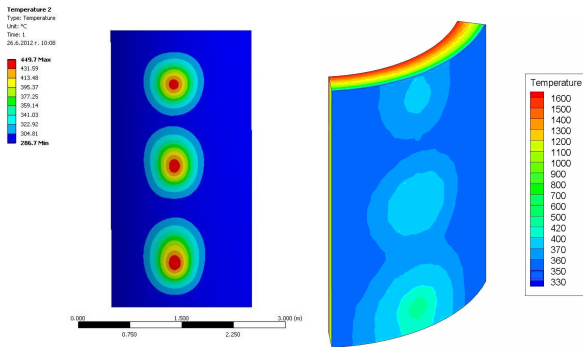

Figure 3. Thermographic images of different spots on the outer surface of the metallurgical ladle.

III. PROPOSED METHOD

Estimation of the thickness of the insulation and lining condition based on some available thermographic measurements is important part of the proper decision making in the condition based maintenance of metallurgical units. Here the most essential problem is to properly estimate the residual inner thickness of the insulation, shown as Z_1 in Fig. 1. Other parameters, such as Z_2 , Z_3 and Z_4 in Fig. 1 are also important for more detailed estimation of the insulation defect [6, 7].

From a diagnostic viewpoint, the residual thickness of the insulation as well as the other parameters of the defect could be represented as solution of the following *inverse problem*:

$$Z_i = f_i(\theta(r)) = f_D^{-1}(\theta(r)) \quad i=1,2,3,4. \quad (1)$$

Here, r is the radius and $\theta(r)$ is the respective temperature of the spot on the outer surface of the metallurgical ladle.

In this paper, it is proposed to create the inverse model from (1) in the form of a RBFNN model with different structures, involving different preselected number of input parameters. Obviously, the set and the list of the input parameters remains a challenging task that is partially solved in this paper in a heuristic way. It is well known that the RBFNN are universal approximators (subject to a proper tuning) [1, 7, 8] and this is the main reason for choosing the RBFNN as diagnostic models in this paper.

IV. BASICS OF THE RBFNN

Among the various possible types of models that can be generated from the available set of Input-Output data, the *Radial Basis Function Neural Network* (RBFNN) models are developed and applied in this paper.

The general structure of a RBFNN model with K inputs, one Output and N RBFs can be illustrated as in Fig. 4.

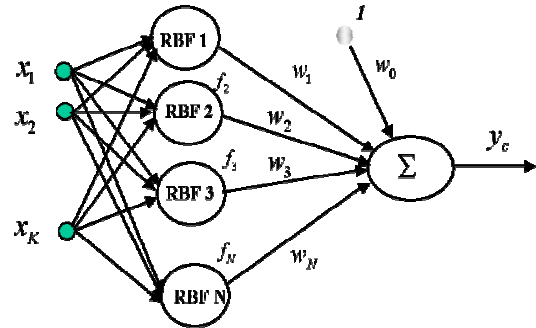

Figure 4. Basic structure of a Radial Basis Function Neural Network (RBFNN) model.

In the one-dimensional case ($K=1$), the Radial Basis Function (RBF) coincides with the well known Gaussian Function, as shown in Fig. 5.

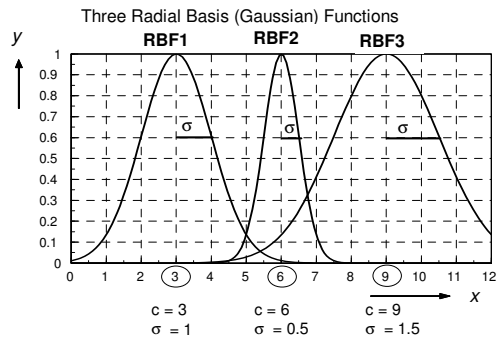

Figure 5. Graphical illustration of three one-dimensional RBFs.

$$y = F(x) = e^{-\frac{(x-c)^2}{2\sigma^2}} \quad (2)$$

Here c denotes the *Center* (location) of the RBF and σ denotes the *Width* (spread) of the RBF.

The number N of the RBFs is usually selected in an experimental way, or is a result of solving some optimization problem.

The tuning parameters for each RBF $F_i(\mathbf{x})$, $i = 1, 2, \dots, N$ are contained into the following set of two K -dimensional vectors: $\{C_i, \sigma_i\}$, $i = 1, 2, \dots, N$, where $C_i = [c_{i1}, c_{i2}, \dots, c_{iK}]^T$ are *Center (Location) Vectors* and $\sigma_i = [\sigma_{i1}, \sigma_{i2}, \dots, \sigma_{iK}]^T$ are the *Width Vectors*.

The *Connection Weights* between the RBFs and the model output y_m form the $N+1$ -dimensional vector $\mathbf{w} = [w_0, w_1, w_2, \dots, w_N]^T$. Thus the complete RBFNN model with N neurons and K inputs will be defined by a total number of $2(N \times K) + (N + 1)$ tuning parameters.

Assumption: Quite often, for simplicity it is assumed that all the width vectors σ_i , $i = 1, 2, \dots, N$ are fixed in advance, that is they are not part of the identification procedure. Of course, this makes the Identification result worse, but simplify the whole computational procedure.

Then the simplified identification problem can be stated as follows: find the connection weights vector $\mathbf{w} = [w_0, w_1, w_2, \dots, w_N]^T$ and the N RBF centre vectors C_i , $i = 1, 2, \dots, N$ ($N \times K + N + 1$ parameters in total) that minimize the prediction error *RMSE* (the *Rooted Mean Square Error*) between the real measured output y and the modelled (predicted) output y_m :

$$RMSE = \sqrt{\frac{1}{M} \sum_{i=1}^M (y_i - y_m^i)^2} \quad (3)$$

In general, the learning algorithms for the RBFNN consist of two separate or sometimes combined procedures: (1) positioning of the RBF centers C_i , $i = 1, 2, \dots, N$ and (2) Estimation of the connection weights $\mathbf{w} = [w_0, w_1, w_2, \dots, w_N]^T$. The first procedure is actually a non-linear optimization problem that can be solved by use of some unsupervised (competitive, self-organizing) iterative learning algorithm. The second procedure is a typical supervised learning problem that is relatively easily solved by a non-iterative linear least squares technique [8].

V. EXPERIMENTAL RESULTS WITH DIFFERENT STRUCTURES OF RBFNN DIAGNOSTIC MODELS

As mentioned in Section III, several different structures of RBFNN models with various combinations of the input-output variables have been developed and investigated in this paper. Each of these models represents one selected subset of 3 or 4 inputs and one output from the complete structure of the *Diagnostic Model* that consists of 7 possible inputs and 4 possible outputs, as shown in Fig. 6.

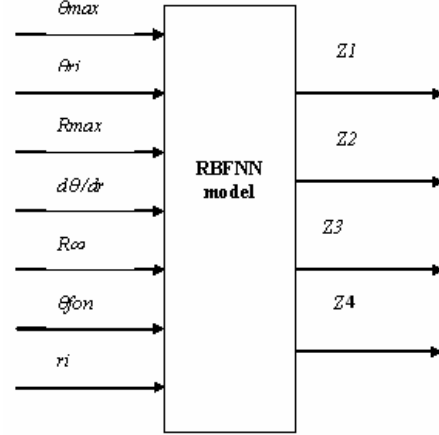

Figure 6. The complete structure of the RBFNN diagnostic model with 7 possible inputs and 4 possible outputs.

It is obvious that in order to construct plausible and reliable diagnostic models (1) we need a large input-output data set obtained by real cases (experiments). However this is a very costly and time consuming process and moreover, it is usually not permitted during real operations of the ladle. In order to avoid all these constrains, we have used in this paper professional software that simulates the metallurgical unit (the ladle) by using first principle models. Thus we were able to generate various cases of defects with different output parameters Z_1 , Z_2 , Z_3 and Z_4 , according to the notations in Fig.6.

As a result, we have produced two input-output data sets, namely, training data set and test data set, each of them consisting of 69 data.

Model A: The first selected structure for a diagnostic model was a RBFNN model with 3 inputs: θ_{max} , R_{max} and R_{∞} and one output: Z_i . The estimation results in the form of *RMSE* error for both the training and the test data sets are given in the following Table I. As seen from this table, three RBFNN models have been generated, with different number of RBFs, namely 6, 11 and 16. In addition, the RBFNN model with 6 RBFs has been generated two times, with different widths of the RBFs. The second model, noted as (*new*) in Table I has bigger RBF widths, respectively bigger overlapping between the neighboring RBFs. As seen from the *RMSE* results in the Table I, this model is a better one.

The worse estimation (prediction) of the Test Data set in the case of 16 RBFs could be explained with the *overfitting* phenomenon (too close approximation of the training data, which are slightly different from the test data).

TABLE I. RBFNN MODELS FOR ESTIMATION OF Z_i

MODEL STRUCTURE		Rooted Mean Square Error (RMSE)	
No. of inputs	No. of RBFs	Training Data Set	Test Data Set
3	6	0.01800	0.04317
3	6 (<i>new</i>)	0.01146	0.01499
3	11	0.01358	0.02695
3	16	0.00921	0.06646

The following Fig. 7 and Fig. 8 illustrate the estimation of the residual thickness Z_I and the respective estimation error for each of the 69 data included in the test data set. These results are given for the RBFNN model with 16 RBFs.

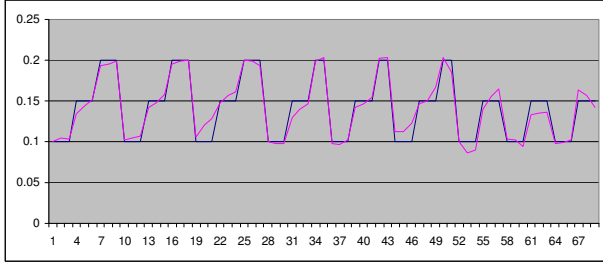

Figure 7. Estimation of the residual thickness Z_I of the insulation, obtained by the RBFNN model with 3 Inputs and 16 RBFs.

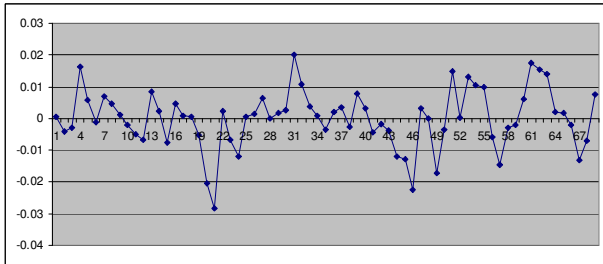

Figure 8. The estimation error of Z_I for each data from the training data set with 69 data.

Model B: The second selected structure of the diagnostic model is in the form of a RBFNN model with another group of 3 inputs: r_i , θ_i , $d\theta/dr_i$; and the same output: Z_I . Two models have been created - with 5 and 10 RBFs. The estimation results are shown in a similar manner in Table II. Here the new point is that another training set, consisting of 76 training data has been used for creating the models.

TABLE II. RBFNN MODELS FOR ESTIMATION OF Z_I

MODEL STRUCTURE		Rooted Mean Square Error (RMSE)	
No. of inputs	No. of RBFs	Training Data Set	Test Data Set
3	5	0.03086	0.05210
3	10	0.03027	0.04855

Illustration of the estimation and the estimation error is given in the following Fig. 9 and Fig. 10 respectively. These results are also for estimation based on the *training data set* only.

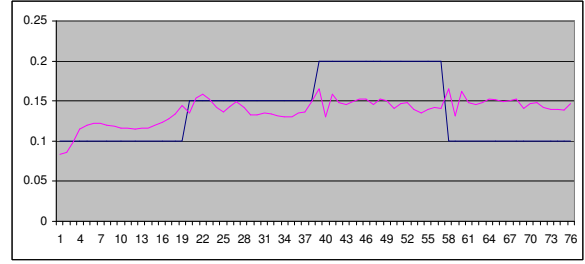

Figure 9. Estimation of the residual thickness Z_I of the insulation, obtained by the RBFNN model with 3 inputs and 10 RBFs.

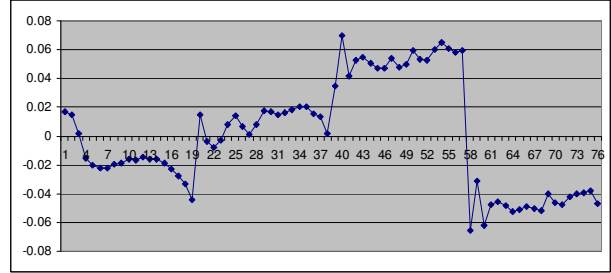

Figure 10. The estimation error of Z_I for each data from the training data set with 76 data.

Model C: The third selected structure for the diagnostic model was a RBFNN model with 4 inputs: θ_{max} , R_{max} , θ_{fon} , R_{∞} and the same one output: Z_I . Here one only model has been generated, namely with 16 RBFs. The estimation results for the training and test data sets are shown in Table III.

TABLE III. RBFNN MODEL FOR ESTIMATION OF Z_I

MODEL STRUCTURE		Rooted Mean Square Error (RMSE)	
No. of inputs	No. of RBFs	Training Data Set	Test Data Set
4	16	0.00934	0.02043

Illustration of the estimation and the estimation error based on the *training data set* are given in Fig. 11 and Fig.12 respectively.

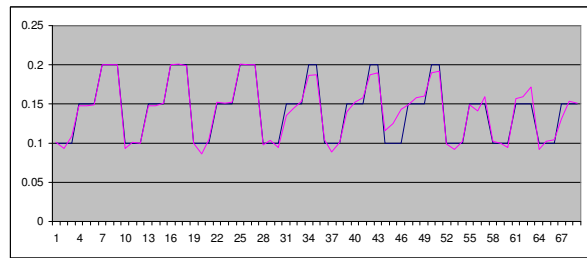

Figure 11. Estimation of the residual thickness Z_I of the insulation, obtained by the RBFNN model with 4 inputs and 16 RBFs.

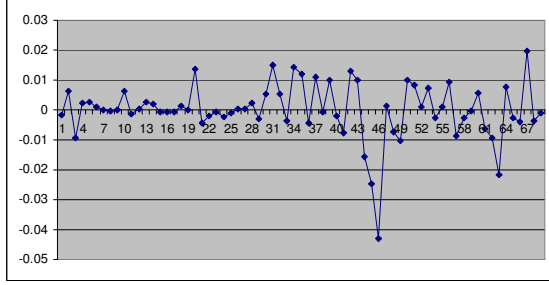

Figure 12. The estimation error of Z_1 for each data from the training data set with 69 data.

As for the estimation and the estimation error, based on the *test data set* for the model from Table III with 4 inputs and 16 RBFs, these are given in the next Fig. 13 and Fig.14.

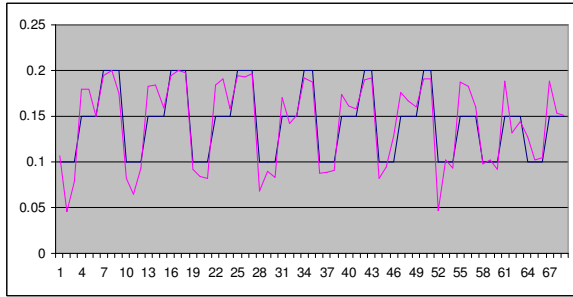

Figure 13. Estimation of the residual thickness Z_1 of the insulation, obtained by the RBFNN model with 4 Inputs and 16 RBFs, based on the test data set.

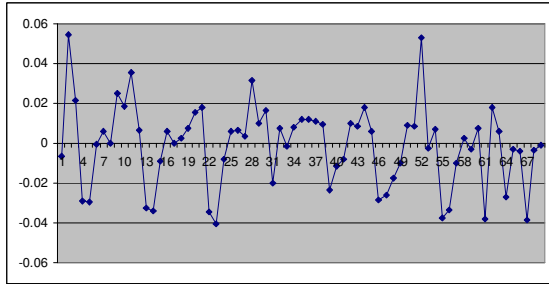

Figure 14. The estimation error of Z_1 for each data from the test data set with 69 data.

Model D: The fourth selected structure of the diagnostic model is in the form of RBFNN with the same set of 4 inputs: θ_{max} , R_{max} , θ_{fov} , R_{∞} but with a different output: Z_3 . The same training and data sets (with 69 data each) have been used here, as in the previous **Model C**.

The estimation results for the training and test data sets are shown in Table IV.

TABLE IV. RBFNN MODEL FOR ESTIMATION OF Z_3

MODEL STRUCTURE		Rooted Mean Square Error (RMSE)	
No. of inputs	No. of RBFs	Training Data Set	Test Data Set
4	16	0.00778	0.02223

Graphical representations of the estimation results for the training data set are shown in Fig. 15 and Fig. 16.

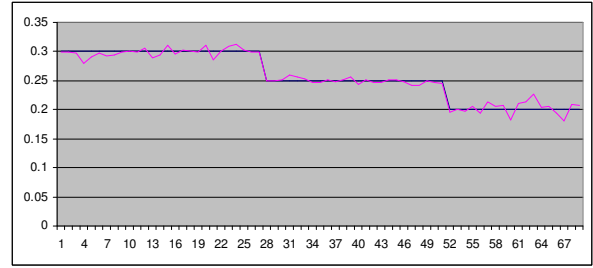

Figure 15. Estimation of the output Z_3 , obtained by the RBFNN model with 4 inputs and 16 RBFs, based on the training data set.

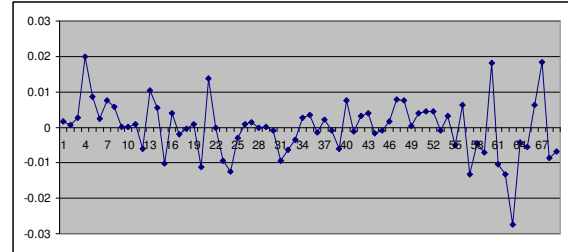

Figure 16. The estimation error of Z_3 for each data from the training data set with 69 data.

Graphical representations of the estimation results for the test data set are shown in the following Fig. 17 and Fig. 18.

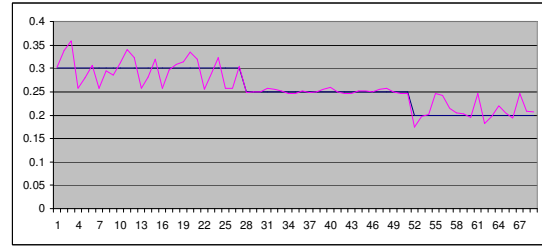

Figure 17. Estimation of the output parameter Z_3 for each data from the test data set with 69 data.

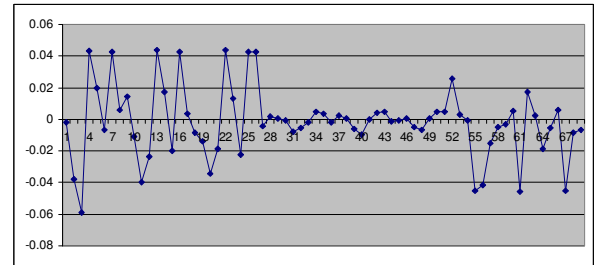

Figure 18. The estimation error of Z_3 for each data from the training data set with 69 data.

Model E: The fifth selected structure of the diagnostic model is in the form of RBFNN with the same set of 4 inputs, as in **Models C** and **Model D**, namely: θ_{max} , R_{max} , θ_{fov} , R_{∞} , but with another output: Z_4 . Here again 16 RBFs have been used to create this model.

The estimation results for the training and test data sets are shown in Table V.

TABLE V. RBFNN MODEL FOR ESTIMATION OF Z_4

MODEL STRUCTURE		Rooted Mean Square Error (RMSE)	
No. of inputs	No. of RBFs	Training Data Set	Test Data Set
4	16	0.03575	0.06442

Finally, graphical representations of the estimation results from this model, based on the training data set with 69 data are shown in Fig. 19 and Fig. 20.

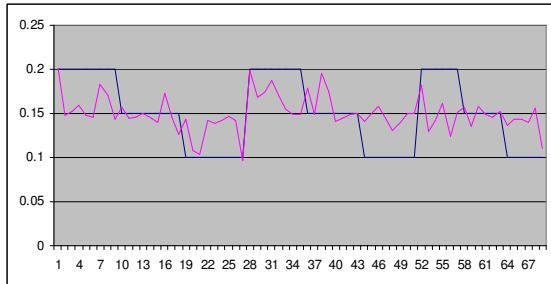

Figure 19. Estimation of the output parameter Z_4 for each data from the training data set with 69 data.

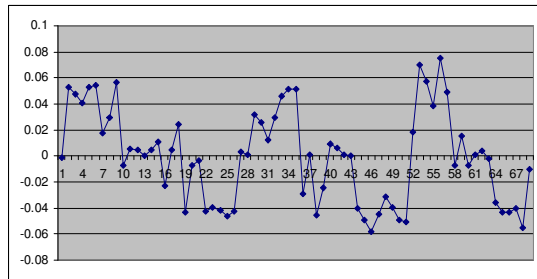

Figure 20. The estimation error of Z_4 for each data from the training data set with 69 data.

All above 5 structures of RBFNN diagnostic models referred to as *Model A*, *Model B*, *Model C*, *Model D* and *Model E*, which have been generated and tested, represent only a small number of all input-output combinations from the complete structure of 7 inputs and 4 outputs, as given in Fig. 6. In fact only 3 sets of inputs (consisting of 3 and 4 parameters) have been tested and the number of tested outputs was also 3, namely Z_1 , Z_3 and Z_4 . Therefore, any analysis and conclusion about “which structure of the model is the best one” would be premature and not reliable. However, creating the complete number of diagnostic models with all combinations of inputs and outputs is a huge and not practical time consuming task, going beyond the goal and scope of this paper.

Based on the above generated 5 types of models, we can make the following approximate conclusions that could be used for a practical implementation of a *reasonably good* diagnostic system.

The *Model A* with three inputs and one output Z_1 that has 6 (*new*) RBFs, as shown in Table I, seems to be the best one for predicting the output Z_1 , since it has the least prediction

error $RMSE = 0.01499$. However this model, with the set of 3 inputs: θ_{max} , R_{max} and R_{∞} is not the best for prediction of another output, such as the output Z_3 .

Therefore, based on the above experimental results, we conclude that another input set of 4 parameters, namely: θ_{max} , R_{max} , θ_{fon} and R_{∞} (being used in *Model C* and *Model D*) is a better choice to create a diagnostic model, since it leads to better prediction results on the *test data set* for both outputs: Z_1 and Z_3 . This is seen from Table III and Table IV, where the prediction error for both outputs is similar one, namely: $RMSE = 0.02043$ for the output Z_1 (*Model C*) and $RMSE=0.02223$ for the output Z_3 (*Model D*).

VI. CONCLUSIONS AND FUTURE WORK

In this paper, it's proposed the usage of RBFNN as a type of diagnostic models, being able to solve the inverse problem (1), in order to predict the parameters Z_1 , Z_2 , Z_3 or Z_4 of the ladle insulation. Since there are at least 7 input parameters that can be taken into account in this diagnostic problem, we have tried to select a RBFNN model with the best possible combination of input parameters that can make a reliable prediction of the output parameters.

By using a relatively small and incomplete list of combinations, our conclusion is that models with 4 inputs could be implemented as a part of a practical diagnostic system for plausible prediction of the outputs Z_1 and Z_3 .

It is clear that the accuracy the RBFNN models depends on the optimal choice of their structural parameters, such as the number of RBFs, their locations and widths in the input space. Therefore, our future work is aimed at optimizing the RBFNN models and creating a systematic approach for selection of the most suitable diagnostic models.

ACKNOWLEDGMENT

This work has been financially supported by the National Science Fund of Bulgaria, Ministry of Education, Youth and Science under the project Diagnostic and Risk Assessment Predictive Asset Maintenance No DVU-10-0267/10.

REFERENCES

- [1] S. Ding, Model-Based Fault Diagnosis Techniques, Springer, 2008.
- [2] M. Fidali, “An Idea of Continuous Thermographic Monitoring of Machinery”, Proc. of the 9th Int. Conf. on Quantitative Infrared Thermography, Krakov, Poland, 2008.
- [3] R. Iserman, Fault-Diagnosis Systems, Springer, 2006.
- [4] A. Jardine, D. Lin, D. Banjevic, “A Review on Machinery Diagnostics and Prognostics, Implementing Condition-Based Maintenance”, Mechanical Systems and Signal Processing, Vol. 20, №7, 2006.
- [5] X.P.V. Maldagne, Theory and Practice of Infrared Thermography for Nondestructive Testing, John Wiley, N.Y.2001.
- [6] E. Mihailov, and V. Petkov, “Case-Based Approach for Diagnosis of Metallurgical Ladle Lining”, The 4th International Conference Processing and Structure of Materials, Palic, Serbia, 27-29 May 2010.
- [7] S. Theodoridis, and K. Koutroumbas, Pattern Recognition, Elsevier, 2008.
- [8] C. Xu, and Y. C. Shin, Intelligent Systems Modeling, Optimization, and Control (Automation and Control Engineering Series) Summary, CRC Press, 2008.